

Industrial Maintenance

Magnetic-Drive Centrifugal Pump

Courseware Sample

37906-F0

Order no.: 37906-70

First Edition

Revision level: 08/2015

By the staff of Festo Didactic

© Festo Didactic Ltée/Ltd, Quebec, Canada 2006

Internet: www.festo-didactic.com

e-mail: did@de.festo.com

Printed in Canada

All rights reserved

ISBN 978-2-89640-026-3 (Printed version)

Legal Deposit – Bibliothèque et Archives nationales du Québec, 2006

Legal Deposit – Library and Archives Canada, 2006

The purchaser shall receive a single right of use which is non-exclusive, non-time-limited and limited geographically to use at the purchaser's site/location as follows.

The purchaser shall be entitled to use the work to train his/her staff at the purchaser's site/location and shall also be entitled to use parts of the copyright material as the basis for the production of his/her own training documentation for the training of his/her staff at the purchaser's site/location with acknowledgement of source and to make copies for this purpose. In the case of schools/technical colleges, training centers, and universities, the right of use shall also include use by school and college students and trainees at the purchaser's site/location for teaching purposes.

The right of use shall in all cases exclude the right to publish the copyright material or to make this available for use on intranet, Internet and LMS platforms and databases such as Moodle, which allow access by a wide variety of users, including those outside of the purchaser's site/location.

Entitlement to other rights relating to reproductions, copies, adaptations, translations, microfilming and transfer to and storage and processing in electronic systems, no matter whether in whole or in part, shall require the prior consent of Festo Didactic.















Information in this document is subject to change without notice and does not represent a commitment on the part of Festo Didactic. The Festo materials described in this document are furnished under a license agreement or a nondisclosure agreement.

Festo Didactic recognizes product names as trademarks or registered trademarks of their respective holders.









All other trademarks are the property of their respective owners. Other trademarks and trade names may be used in this document to refer to either the entity claiming the marks and names or their products. Festo Didactic disclaims any proprietary interest in trademarks and trade names other than its own.

Safety and Common Symbols

The following safety and common symbols may be used in this manual and on the equipment:

Symbol	Description
	DANGER indicates a hazard with a high level of risk which, if not avoided, will result in death or serious injury.
	WARNING indicates a hazard with a medium level of risk which, if not avoided, could result in death or serious injury.
	CAUTION indicates a hazard with a low level of risk which, if not avoided, could result in minor or moderate injury.
	CAUTION used without the <i>Caution, risk of danger</i> sign  , indicates a hazard with a potentially hazardous situation which, if not avoided, may result in property damage.
	Caution, risk of electric shock
	Caution, hot surface
	Caution, risk of danger
	Caution, lifting hazard
	Caution, hand entanglement hazard
	Notice, non-ionizing radiation
	Direct current
	Alternating current
	Both direct and alternating current
	Three-phase alternating current

Safety and Common Symbols

Symbol	Description
	Earth (ground) terminal
	Protective conductor terminal
	Frame or chassis terminal
	Equipotentiality
	On (supply)
	Off (supply)
	Equipment protected throughout by double insulation or reinforced insulation
	In position of a bi-stable push control
	Out position of a bi-stable push control

We invite readers of this manual to send us their tips, feedback, and suggestions for improving the book.

Please send these to did@de.festo.com.

The authors and Festo Didactic look forward to your comments.

Table of Contents

Preface	VII
About This Manual	IX
Work Order 1 Magnetic-Drive Centrifugal Pump	1
Appendix A Equipment Utilization Chart.....	15
Appendix B Safety Procedures	17
Appendix C Types of Liquid Pumps	19
Appendix D Variable Speed Drive – Parameter Reference Table	21
Appendix E Troubleshooting Chart	23

To the Instructor

NCCER Accreditation

Contact the National Center for Construction Education and Research (NCCER), at www.nccer.org, to obtain the requirements relative to the NCCER accreditation of this course.

Care and Maintenance of the Pumps Training System

Every week

- Check the general condition of the Pumps Training System.
- Check the condition of the snap-grip clamps on the hoses.
- Make sure the expanding work surface is solidly fixed on the bench. Check the condition of the four (4) push-lock fasteners.

Once a month

- Check the operation of the ground fault circuit interrupter (GFCI).
- Make sure that an O-ring is present and in good condition in each hose coupling.

Every 6 months

- Replace the water in the reservoir.
- Add the following solutions to the water in the reservoir:
 - 2 fl oz (60 ml) of Antibacterial solution, Lab-Volt p/n 38097
 - 8 fl oz (240 ml) of Rust inhibitor, Lab-Volt p/n 38096

Sample Work Order

Extracted from

Magnetic-Drive

Centrifugal Pump

Magnetic-Drive Centrifugal Pump

Description

The Magnetic-Drive Centrifugal Pump of your training system is shown in Figure 1-1. It consists of a centrifugal pump that is magnetically driven. Magnetic Drive Pumps, also called sealless pumps, were originally designed to pump toxic and other dangerous fluids without the use of mechanical seals.

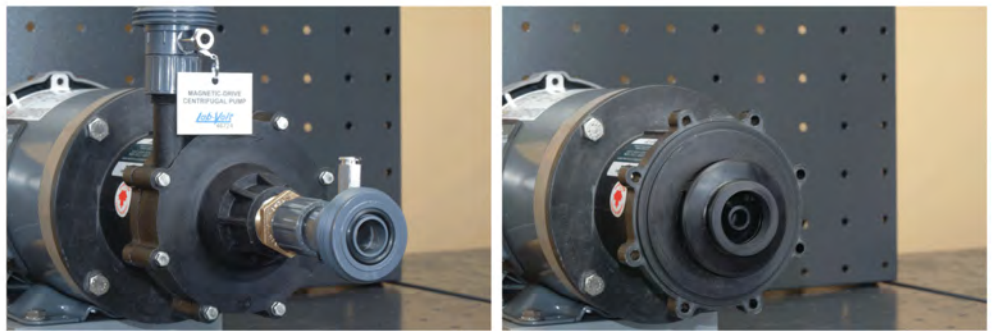

Figure 1-1. Magnetic-Drive Centrifugal Pump with and without housing.

How it works

Magnetic coupling consists of two magnets, a drive magnet that attaches to the motor shaft and a driven magnet that is completely sealed within the pump head. The driven magnet is a wetted component and is encapsulated. The impeller shaft is supported on sleeve bearings lubricated by the pumped fluid. See Figure 1-2.

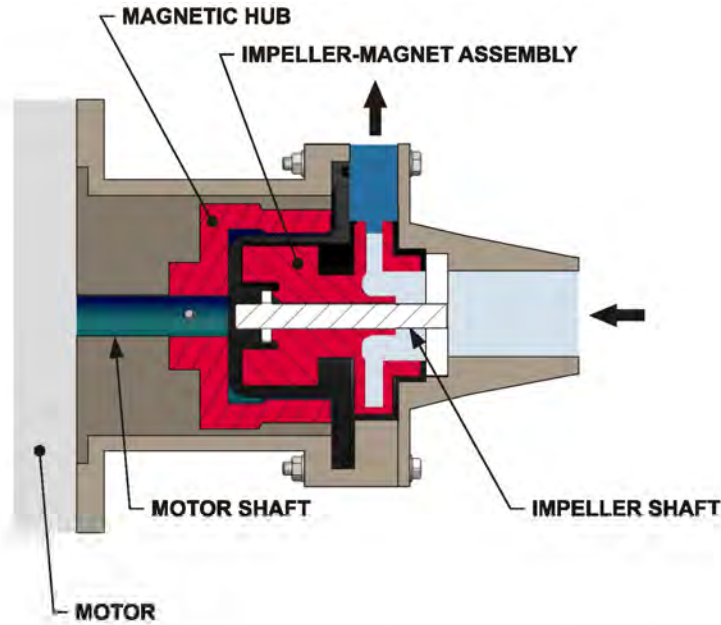

Figure 1-2. Magnetic-Drive Centrifugal Pump.

The magnetic coupling disengages when the pump load exceeds the coupling torque between the two magnets. This feature can act as a safety device to prevent damage to the pump and motor.

Advantages and disadvantages

Advantages: No seals in contact with the pumped fluid. They do not create pressure pulsations. The magnetic coupling disengages when the coupling torque is too high. They require very low maintenance.

Disadvantages: The magnetic coupling and the product-wetted bearings have weaknesses and limitations. The magnetic-drive pumps can only run dry for very short periods.

Applications

Magnetic-drive centrifugal pumps are designed to meet the demands of a wide range of industrial applications. Since they do not have seals in contact with the pumped fluid, they can be used for highly corrosive or mild chemicals such as acids, solvents, alkalies, caustics, bleaches, sea water, and many harsh environments.

They are found in chemical plants, pharmaceutical plants, water and wastewater treatment plants, and electronics manufacturing.

Maintenance

The maintenance required by Magnetic-Drive Centrifugal Pumps consists of:

- Inspecting and cleaning the internal components at the intervals suggested by the manufacturer.

Note: *An exploded view of the Magnetic-Drive Centrifugal Pump is shown in Figure 1-3.*

Characteristics of the Magnetic-Drive Centrifugal Pump of the training system

Maximum speed: 3450 r/min

Maximum discharge pressure: 16 psi (42 kPa)

Maximum flow: 32 gal US/min (159 l/min)

Magnetic-Drive Centrifugal Pump

Task: To disassemble, inspect, assemble, install, operate, and troubleshoot a magnetic-drive centrifugal pump.

PROCEDURE

CAUTION!



Before proceeding with this work order, complete the safety checklist in Appendix B.

- 1. Refer to Figure 1-3 to locate and identify the various components of the Magnetic-Drive Centrifugal Pump.

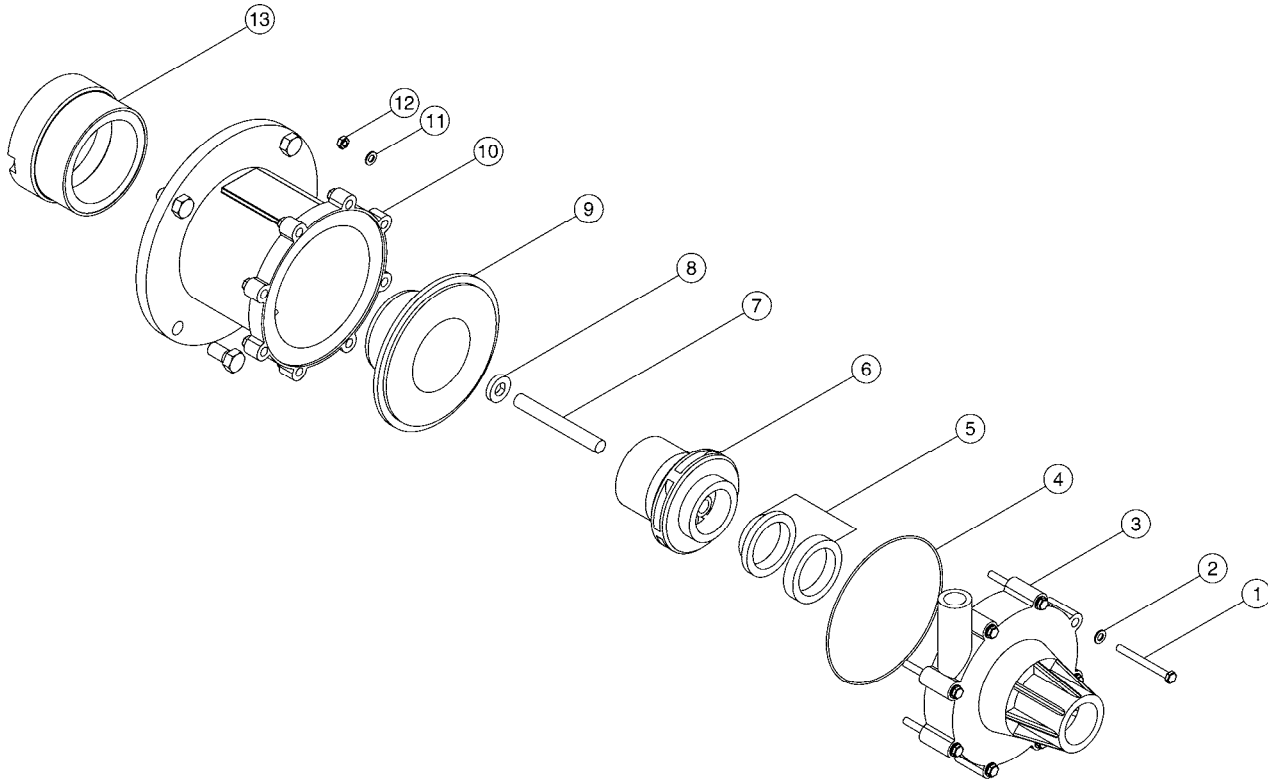

Figure 1-3. Exploded view of the Magnetic-Drive Centrifugal Pump.

- | | | | |
|---|--------------------------|----|--------------|
| 1 | Screw | 8 | Shaft ring |
| 2 | Washer | 9 | Rear casing |
| 3 | Pump head | 10 | Bracket |
| 4 | O-ring | 11 | Washer |
| 5 | Thrust bearing | 12 | Nut |
| 6 | Impeller-magnet assembly | 13 | Magnetic hub |
| 7 | Shaft | | |

Disassembly of the Magnetic-Drive Centrifugal Pump

- 2. Disassemble the pump as follows:

Note: Be careful with the shaft when disassembling the pump. It is made of ceramic, which is fragile and may easily be damaged.

- Remove the magnetic hub.
- Remove the screws and washers.
- Slowly remove the bracket.
- Slowly remove the rear casing and O-ring.
- Slowly remove the impeller-magnet assembly.

- Remove the thrust bearing half and the shaft ring from the impeller-magnet assembly.
- Remove the shaft.
- Do not remove the thrust bearing half (white section) from the pump head.

Inspection

- 3. Clean all components, remove all hardened residues.
- 4. Check the components as follows:
 - Examine the thrust bearing, shaft, and shaft ring for excessive radial play.
 - Inspect the impeller-magnet assembly and O-ring for wear.

Note: *Notify your instructor if any parts seem damaged.*

Reassembly of the pump

- 5. Reassemble the pump as follows:
 - Place the rear casing, with the opening on top, on a flat surface.
 - Install the O-ring.
 - Install the shaft ring, and shaft. Check the orientation.
 - Insert the thrust bearing half in the impeller-magnet assembly.
 - Insert the impeller-magnet assembly in the rear casing.
 - Attach the bracket to the pump head. Make sure that the drain hole in the pump bracket is at the bottom. Do not overtighten.

Lubrication

Note: *The Magnetic-Drive Centrifugal Pump does not require special lubrication.*

Circuit setup

- 6. Install the Motor on the Pump Universal Base.
- 7. Place the magnetic coupling on the Motor shaft, locating the coupling so the setscrew will tighten into the Motor key way.

Note: *Be careful to not damage the Motor shaft surface.*

Position the magnetic coupling so it is flush with the end of the Motor shaft as shown in Figure 1-4, and tighten the setscrew.

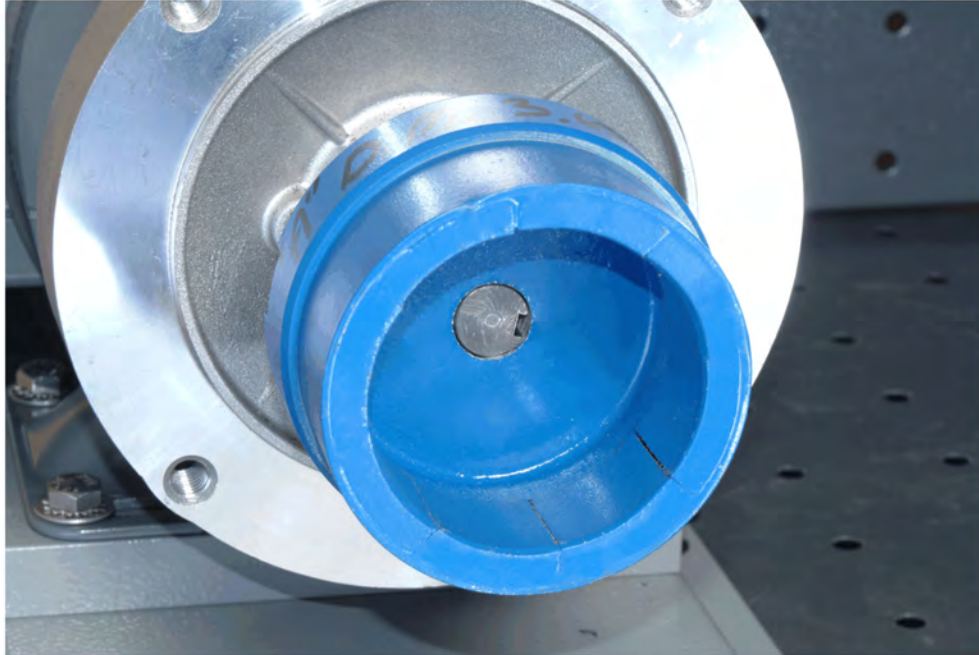

Figure 1-4. Install the magnetic coupling on the Motor shaft.

- 8. Attach the pump head to the Motor, tighten the screws.
- 9. Set up the pumping circuit shown in Figure 1-5.

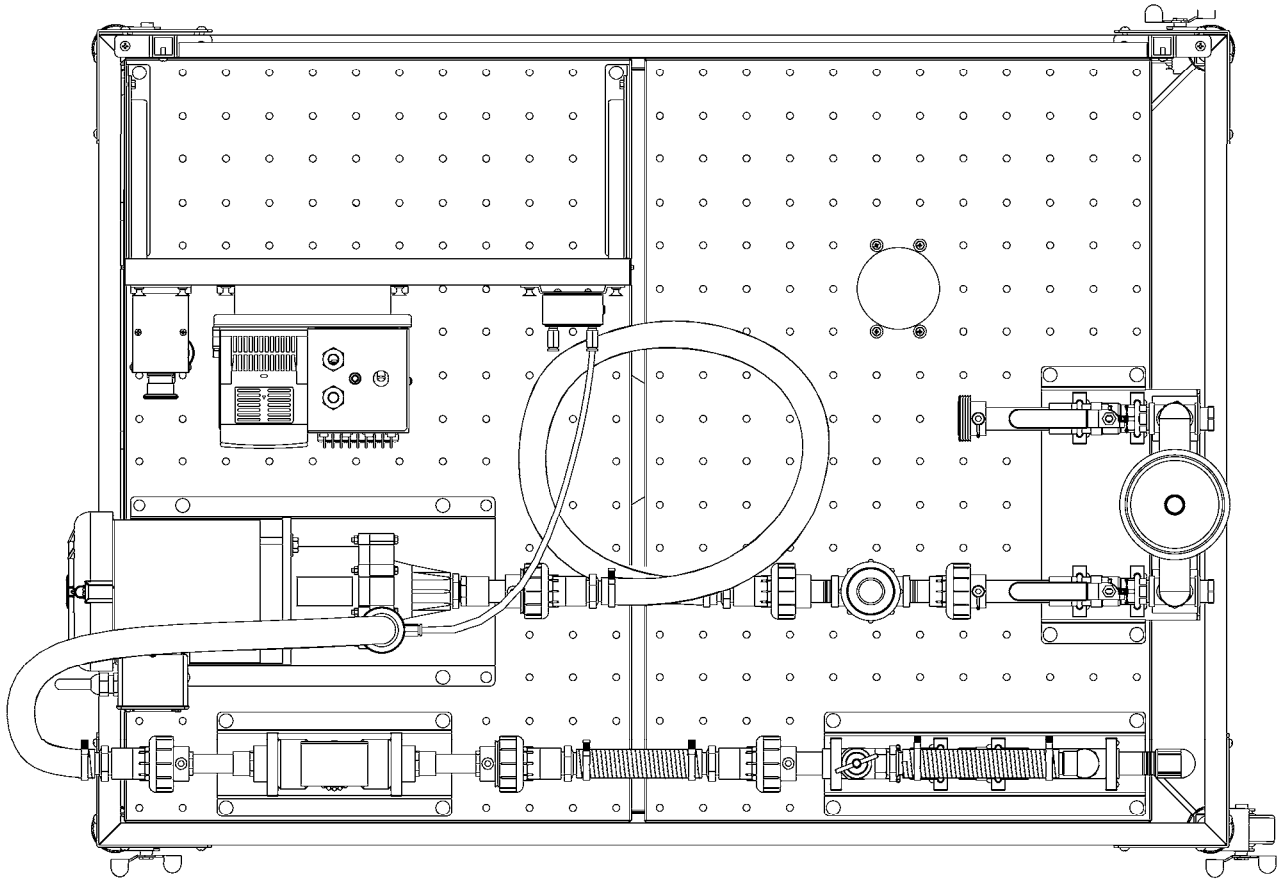

Figure 1-5. Pumping circuit using the Magnetic-Drive Centrifugal Pump.

- 10. Connect the Variable Speed Drive and Motor.
- 11. Prime the pump.



CAUTION!

Never run the Magnetic-Drive Centrifugal Pump dry or with a closed discharge line. The shaft and/or the thrust bearing will be damaged if run dry, the rear casing will distort if run with a closed discharge line.

- 12. Perform the following settings on the Variable Speed Drive:
 - Set the maximum output frequency to 60 Hz.
 - Set the direction of rotation to forward.

- 13. Turn the control knob of the relief valve fully clockwise to block the alternate flow path.

Flow rate versus speed

- 14. Determine the flow rate versus speed characteristics as follows:
 - Open valve HV-4.
 - On the Variable Speed Drive, increase the output frequency from 0 to 60 Hz by increments of 10 Hz. For each setting, measure the flow rate and enter your results in Table 1-1.

OUTPUT FREQUENCY (Hz)	0	10	20	30	40	50	60
FLOW RATE							

Table 1-1. Flow rate versus output frequency.

- 15. Plot the flow rate versus speed (60 Hz \approx 3450 r/min) curve in Figure 1-6.

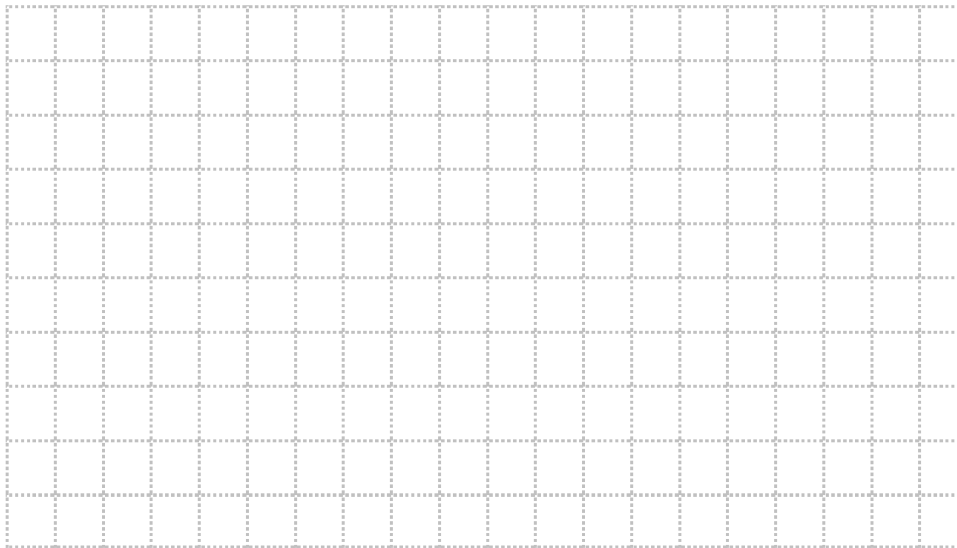

Figure 1-6. Flow rate versus speed curve.

Head versus flow rate

- 16. Determine the head versus flow rate characteristics as follows:
 - Make sure valve HV-4 is open.
 - On the Variable Speed Drive, set the output frequency to 40 Hz.

- 18. Plot the head versus flow rate curves in Figure 1-7.

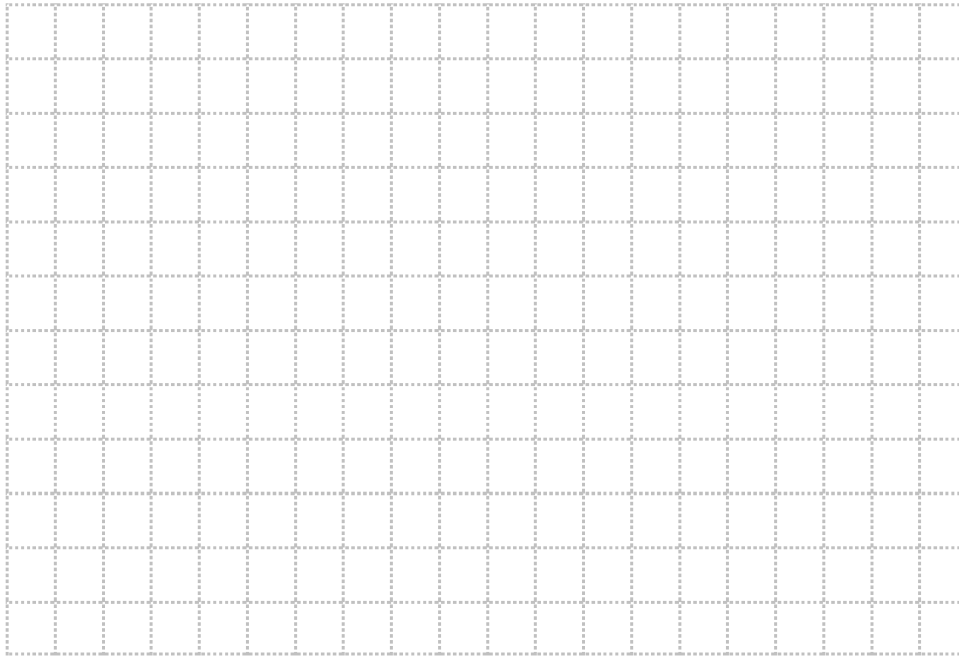

Figure 1-7. Head versus flow rate.

Troubleshooting

- 19. By referring to the Troubleshooting Chart in Appendix E, identify two symptoms that a clogged strainer may cause.

- 20. By referring to the Troubleshooting Chart in Appendix E, name three possible causes for a low flow rate.

- 21. Ask your instructor to check your work.

- 22. Disconnect your setup, clean the strainer, and return the equipment to the storage location.

Name: _____ Date: _____

Instructor's approval: _____